



















		2'-8 1/4" [819]	3'-2 1/4" [972]	4'-2 1/4" [1276]	5'-0" [1524]	6'-0" [1829]	8'-0" [2438]
		31 1/4" [794]	37 1/4" [946]	49 1/4" [1251]	59" [1498]	71" [1802]	95" [2412]
		25 1/4" [642]	31 1/4" [794]	43 1/4" [1099]	25 1/4" [642]	31 1/4" [794]	43 1/4" [1099]
		FIXED UNITS			OPERATING UNITS		
OPENING	6'-8" [2032]						
	6'-11" [2109]						
	8'-0" [2439]						
FRAME	79 3/8" [2016]						
	82 3/8" [2093]						
	86 3/8" [2195]						
GLASS	70 3/8" [1788]						
	73 3/8" [1865]						

Brickmould Note:























































To get the Brickmould Width, add 3" (76mm) to Frame Width.

To get the Brickmould Height, add 1-1/2" (38mm) to Frame Height.

NOTE:

" F " DENOTES A FIXED PANEL, " R " DENOTES THE ROLLING PANEL, AS VIEWED FROM THE EXTERIOR OF THE DOOR.



























ALL " RF " DOORS SHOWN ARE ALSO AVAILABLE AS " FR "

		31 1/4" [794]	37 1/4" [946]	49 1/4" [1251]	59" [1498]	71" [1802]	95" [2412]
		25 1/4" [642]	31 1/4" [794]	43 1/4" [1099]	53" [1346]	65" [1650]	89" [2260]
FRAME	15 3/4" [400]	 WPDT28/4	 WPDT32/4	 WPDT42/4	 WPDT50/4	 WPDT60/4	 WPDT80/4
	9 3/4" [248]						
GLASS	19 11/16" [500]	 WPDT28/5	 WPDT32/5	 WPDT42/5	 WPDT50/5	 WPDT60/5	 WPDT80/5
	13 11/16" [348]						
GLASS	23 5/8" [600]	 WPDT28/6	 WPDT32/6	 WPDT42/6	 WPDT50/6	 WPDT60/6	 WPDT80/6
	17 5/8" [448]						
GLASS	27 9/16" [700]	 WPDT28/7	 WPDT32/7	 WPDT42/7	 WPDT50/7	 WPDT60/7	 WPDT80/7
	21 9/16" [548]						
GLASS	31 1/2" [800]	 WPDT28/8	 WPDT32/8	 WPDT42/8	 WPDT50/8	 WPDT60/8	 WPDT80/8
	25 1/2" [648]						
GLASS	35 7/16" [900]	 WPDT28/9	 WPDT32/9	 WPDT42/9	 WPDT50/9	 WPDT60/9	 WPDT80/9
	29 7/16" [748]						
GLASS	39 3/8" [1000]	 WPDT28/10	 WPDT32/10	 WPDT42/10	 WPDT50/10	 WPDT60/10	 WPDT80/10
	33 3/16" [848]						
GLASS	43 5/16" [1100]	 WPDT28/11	 WPDT32/11	 WPDT42/11	 WPDT50/11	 WPDT60/11	 WPDT80/11
	37 5/16" [948]						
GLASS	47 1/4" [1200]	 WPDT28/12	 WPDT32/12	 WPDT42/12	 WPDT50/12	 WPDT60/12	 WPDT80/12
	41 1/4" [1048]						

Brickmould Note:

To get the Brickmould Width, add 3" (76mm) to Frame Width.

To get the Brickmould Height, add 2" (51mm) to Frame Height.

		59" [1498]	71" [1802]	95" [2412]
		23 1/2" [597]	29 1/2" [749]	41 1/2" [1054]
FRAME GLASS	15 3/4" [400]			
	19 11/16" [500]			
	23 5/8" [600]			
	27 9/16" [700]			
	31 1/2" [800]			
	35 7/16" [900]			
	39 3/8" [1000]			
	43 5/16" [1100]			
	47 1/4" [1200]			
	9 3/4" [248]			
	13 11/16" [348]			
	17 5/8" [448]			
21 9/16" [548]				
25 1/2" [648]				
29 7/16" [748]				
33 3/16" [848]				
37 5/16" [948]				
41 1/4" [1048]				

Brickmould Note:

To get the Brickmould Width, add 3" (76mm) to Frame Width.
To get the Brickmould Height, add 2" (51mm) to Frame Height.

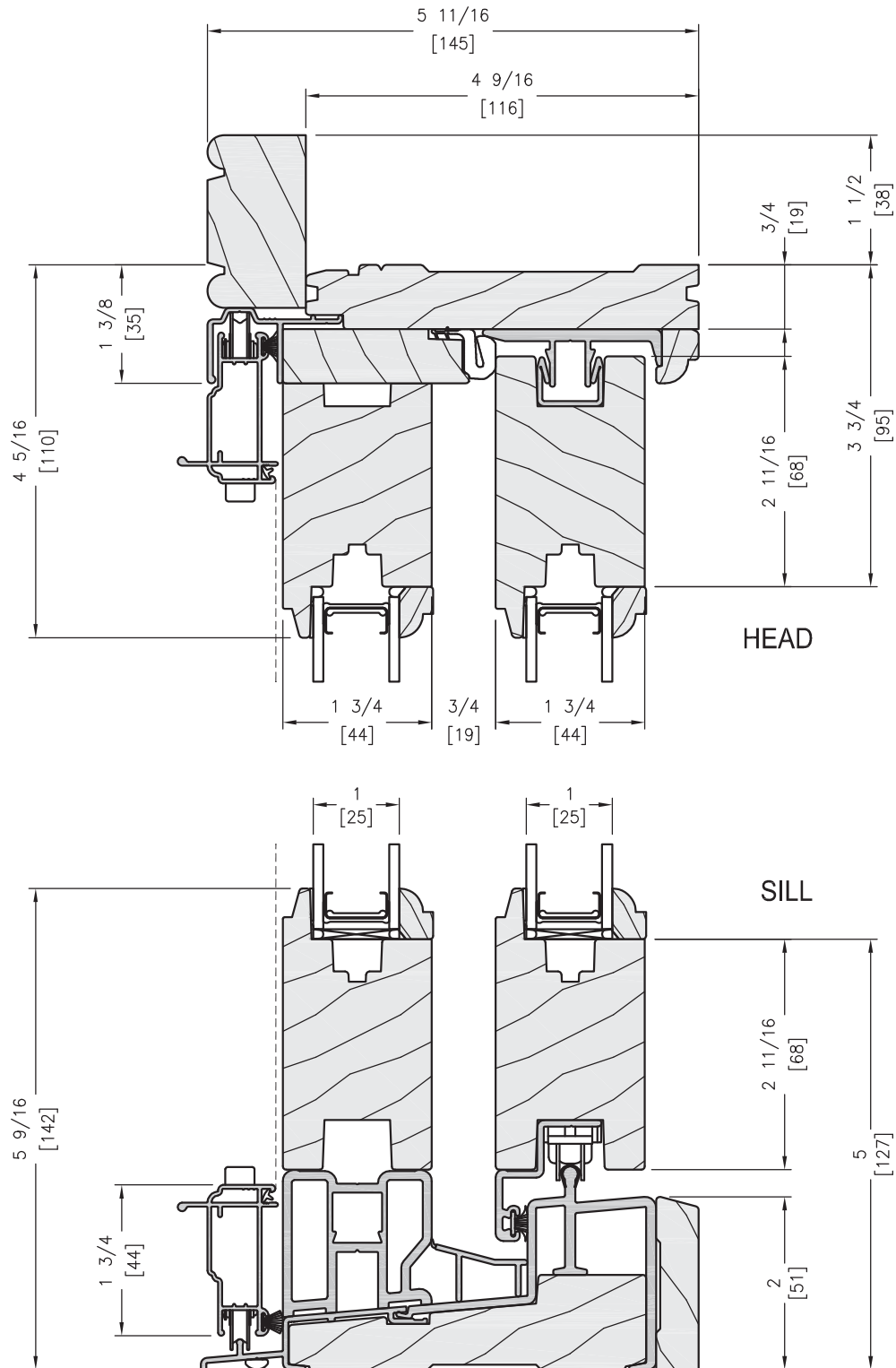
SCALE: 6" = 1'-0"
VERTICAL SECTION

UNIT DRAWN WITH STANDARD BRICKMOULD

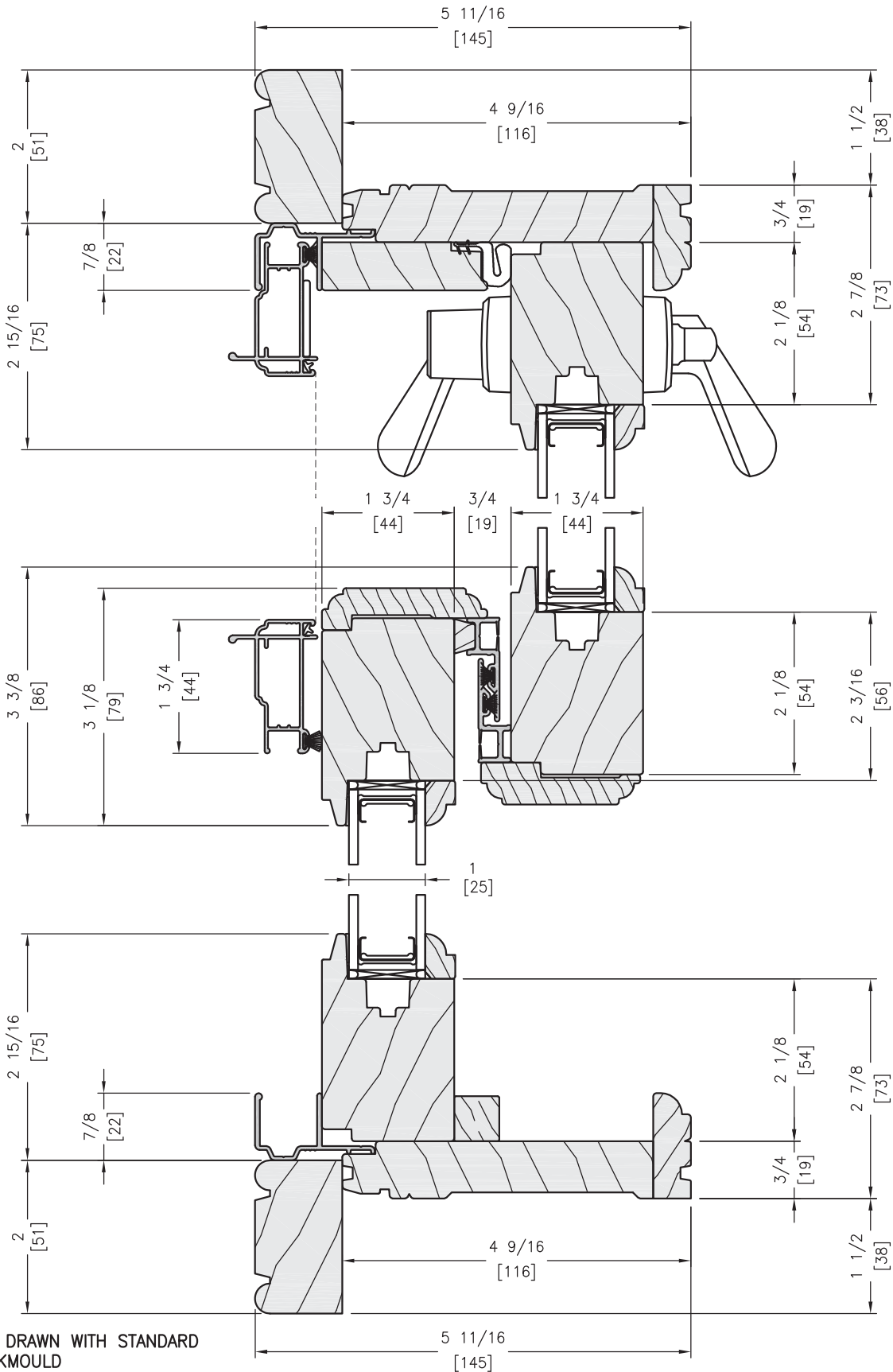
SCALE: 6" = 1'-0"
HORIZONTAL SECTION

LOCK JAMB
MEETING RAILS
FIXED JAMB
**UNIT DRAWN WITH STANDARD
BRICKMOULD**

SCALE: 6" = 1'-0"

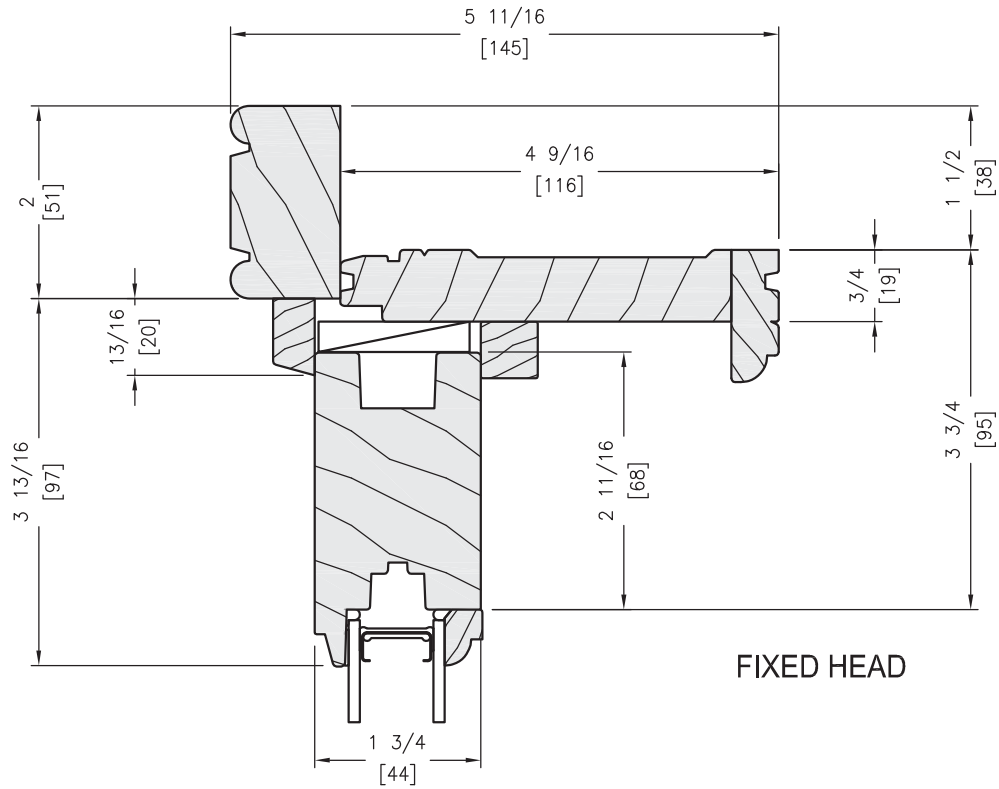
FIXED SIDELIGHT VERTICAL SECTION

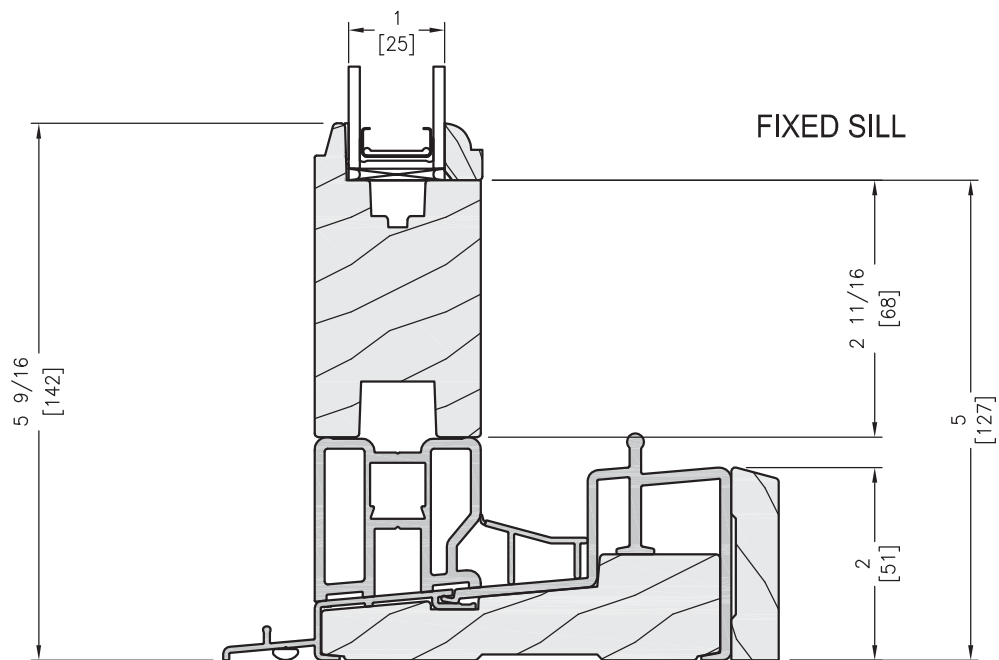

FIXED HEAD



FIXED SILL

UNIT DRAWN WITH STANDARD BRICKMOULD

SCALE: 6" = 1'-0"

FIXED SIDELIGHT HORIZONTAL SECTION

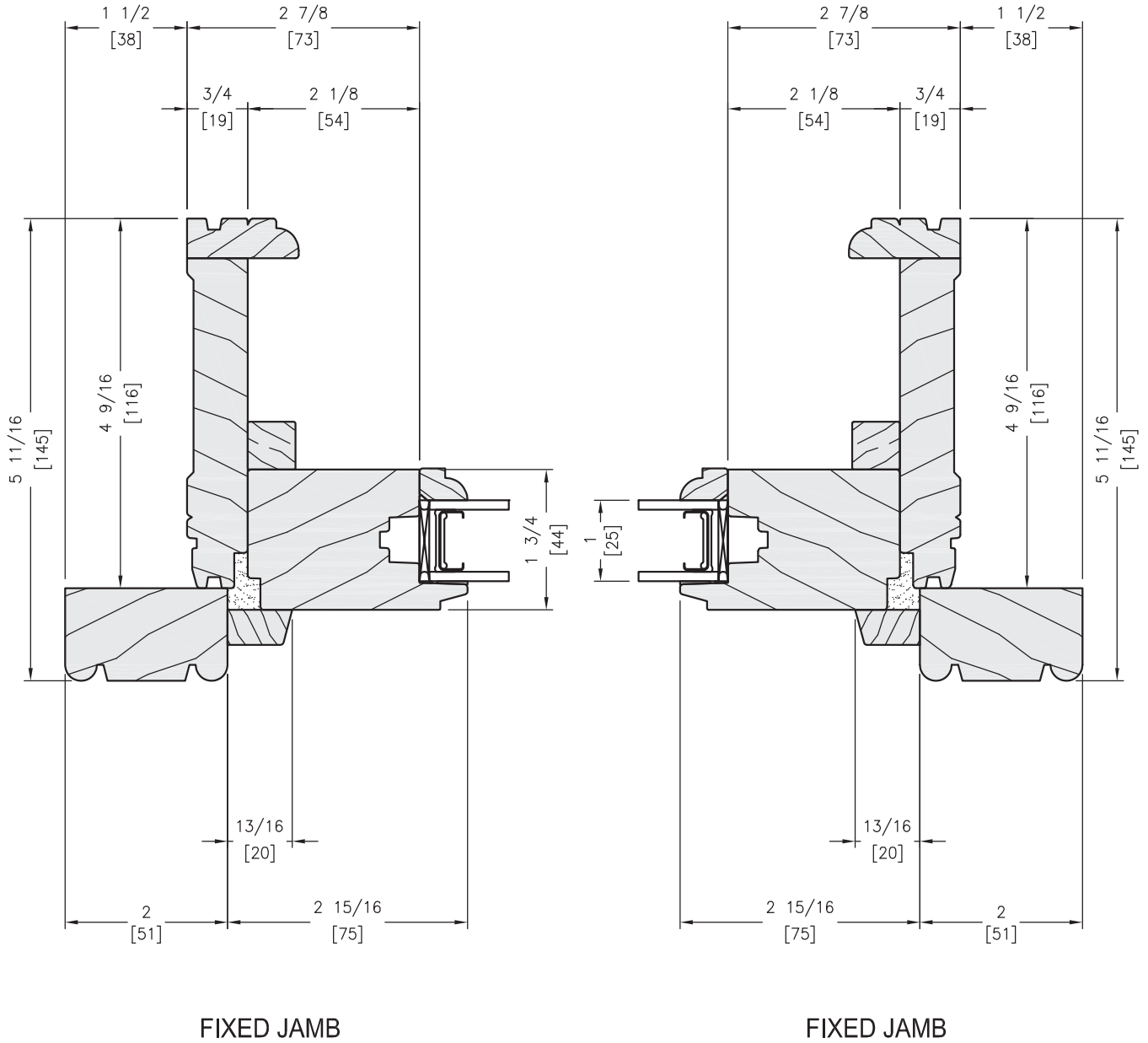

UNITS DRAWN WITH STANDARD BRICKMOULD

SCALE: 3" = 1'-0"

FIXED TRANSOM VERTICAL SECTION

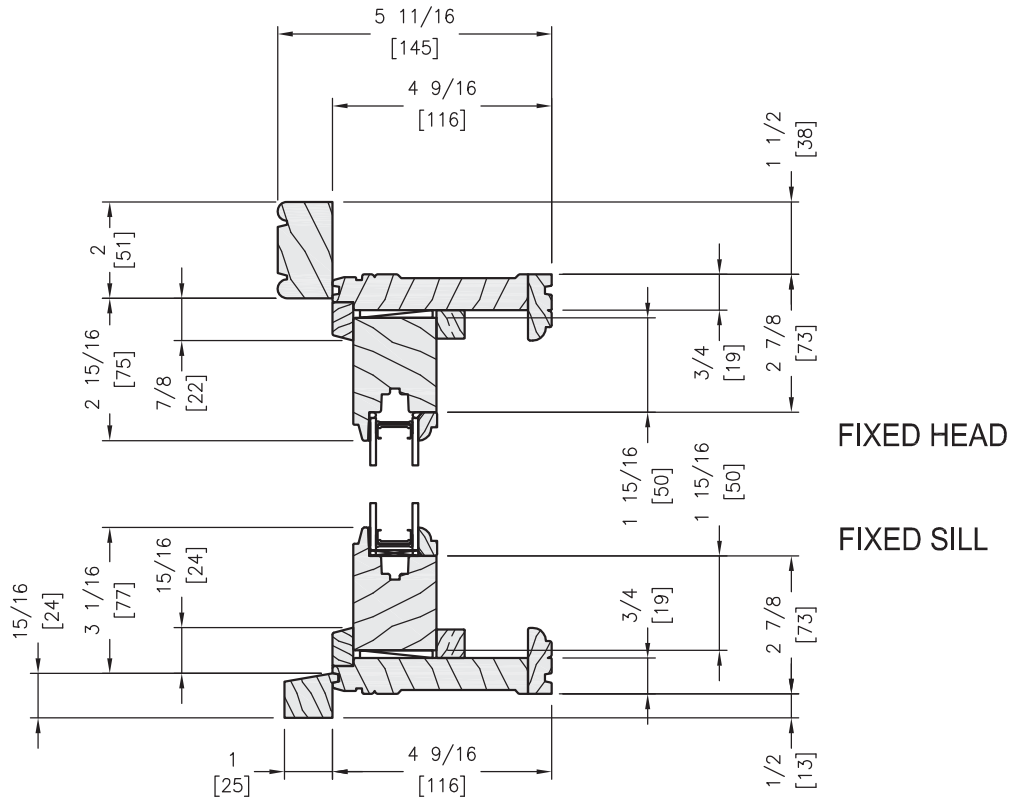

SCALE: 3" = 1'-0"

FIXED TRANSOM HORIZONTAL SECTION

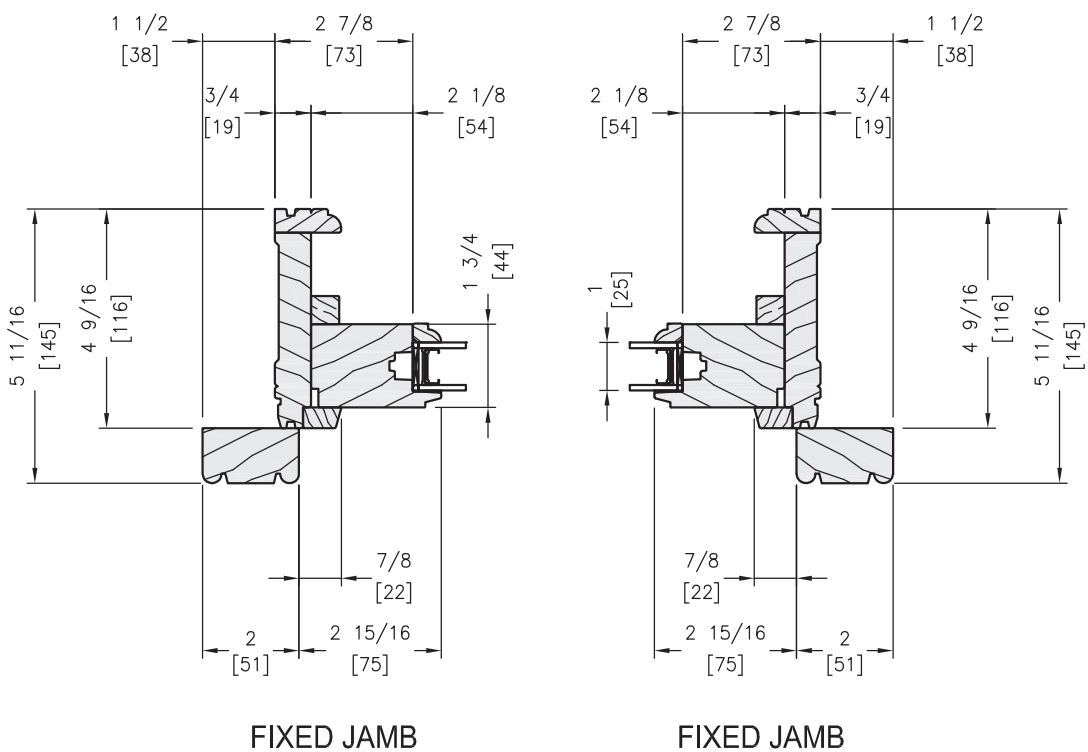

SCALE: 3" = 1'-0"

VERTICAL JOINING MULLIONS

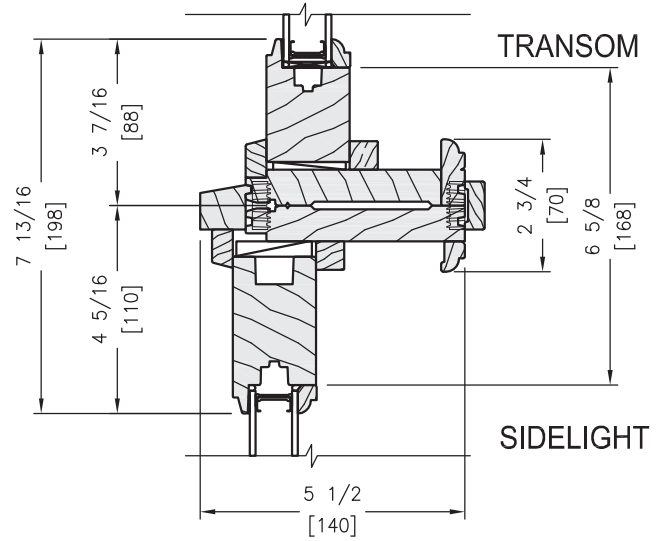
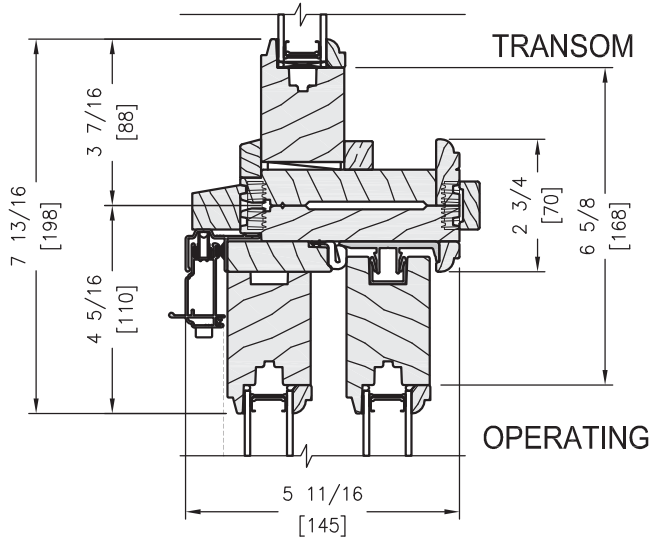

SCALE: 3" = 1'-0"

HORIZONTAL JOINING MULLIONS

