













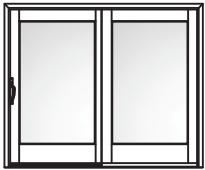





































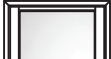
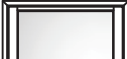
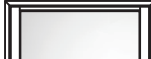
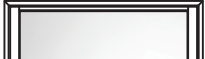



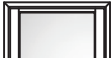

		2'-8 1/4" [819]	3'-2 1/4" [972]	4'-2 1/4" [1276]	5'-0" [1524]	6'-0" [1829]	8'-0" [2438]
		31 1/4" [794]	37 1/4" [946]	49 1/4" [1251]	59" [1498]	71" [1802]	95" [2412]
		20" [508]	26" [660]	38" [965]	20" [508]	26" [660]	38" [965]
		FIXED UNITS			OPERATING UNITS		
OPENING	6'-8" [2032]						
	79 3/8" [2016]						
	61" [1549]						
FRAME	6'-11" [2108]						
	82 3/8" [2093]						
	64" [1626]						
GLASS	8'-0" [2439]						
	95 3/8" [2423]						
	77" [1956]						

Brickmould Note:

To get the Brickmould Width, add 3" (76mm) to Frame Width.
To get the Brickmould Height, add 1-1/2" (38mm) to Frame Height.



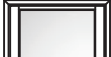
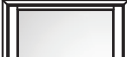
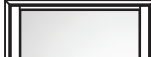
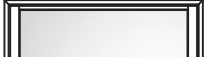

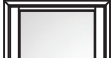
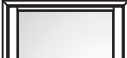
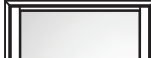
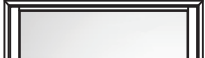





















NOTE:

" F " DENOTES A FIXED PANEL, " R " DENOTES THE ROLLING PANEL, AS VIEWED FROM THE EXTERIOR OF THE DOOR.
ALL " RF " DOORS SHOWN ARE ALSO AVAILABLE AS " FR "

		31 1/4" [794]	37 1/4" [946]	49 1/4" [1251]	59" [1498]	71" [1802]	95" [2412]		
		20" [508]	26" [660]	38" [965]	47 3/8" [1212]	59 5/8" [1516]	83 3/8" [2126]		
FRAME	GLASS	15 3/4" [400]	9 3/4" [248]						
		19 11/16" [500]	13 11/16" [348]						
		23 5/8" [600]	17 5/8" [448]						
		27 9/16" [700]	21 9/16" [548]						
		31 1/2" [800]	25 1/2" [648]						
		35 7/16" [900]	29 7/16" [748]						
		39 3/8" [1000]	33 3/16" [848]						
		43 5/16" [1100]	37 5/16" [948]						
		47 1/4" [1200]	41 1/4" [1048]						

Brickmould Note:

To get the Brickmould Width, add 3" (76mm) to Frame Width.
To get the Brickmould Height, add 2" (51mm) to Frame Height.

		59" [1498]	71" [1802]	95" [2412]
		18 1/4" [463]	24 1/4" [615]	36 1/4" [920]
FRAME GLASS	15 3/4" [400]			
	19 11/16" [500]			
	23 5/8" [600]			
	27 9/16" [700]			
	31 1/2" [800]			
	35 7/16" [900]			
	39 3/8" [1000]			
	43 5/16" [1100]			
	47 1/4" [1200]			
	9 3/4" [248]			
	13 11/16" [348]			
	17 5/8" [448]			
21 9/16" [548]				
25 1/2" [648]				
29 7/16" [748]				
33 3/16" [848]				
37 5/16" [948]				
41 1/4" [1048]				

Brickmould Note:

To get the Brickmould Width, add 3" (76mm) to Frame Width.
To get the Brickmould Height, add 2" (51mm) to Frame Height.

SCALE: 6" = 1'-0"

VERTICAL SECTION

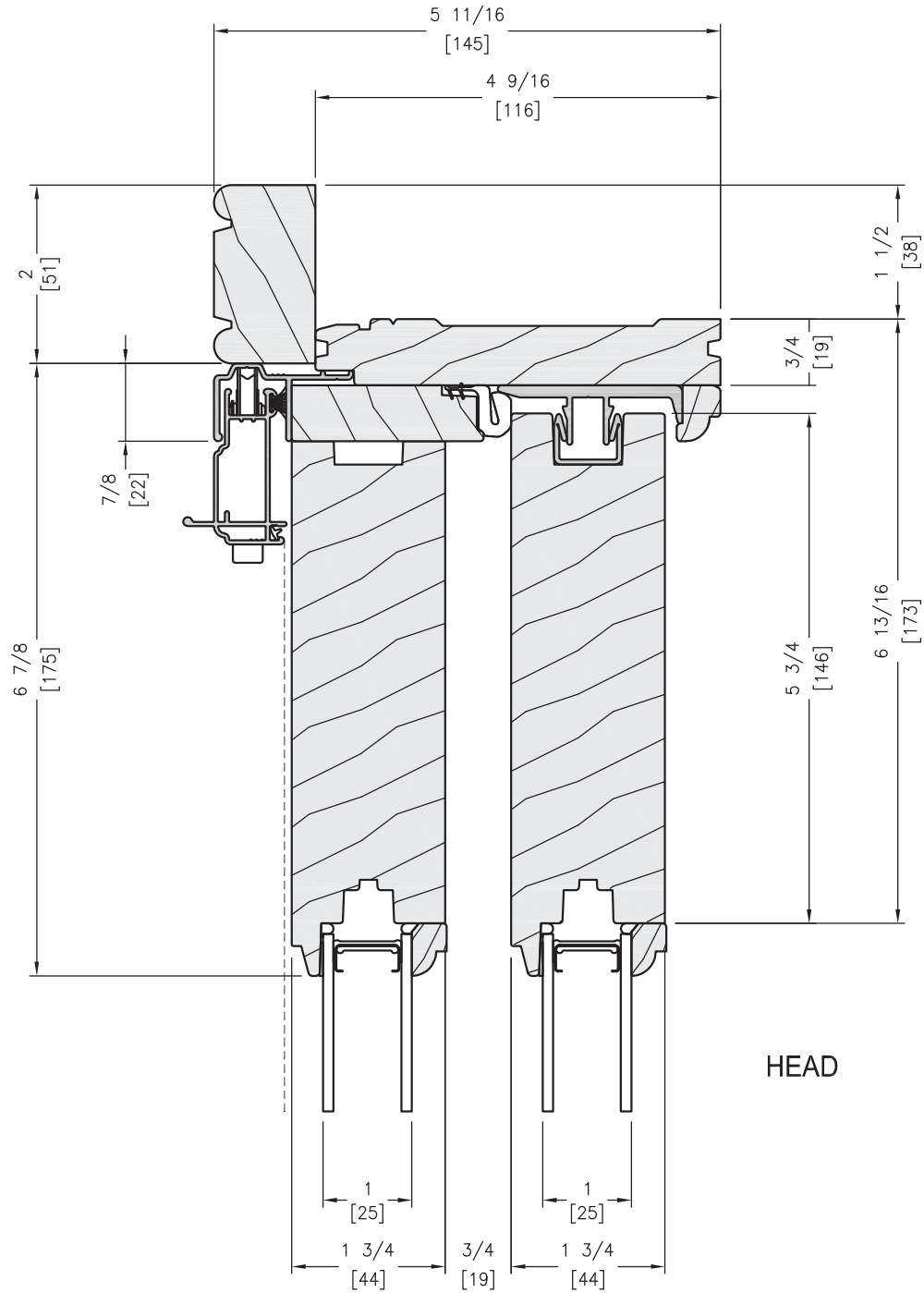

UNIT DRAWN WITH STANDARD BRICKMOULD

SCALE: 6" = 1'-0"

VERTICAL SECTION

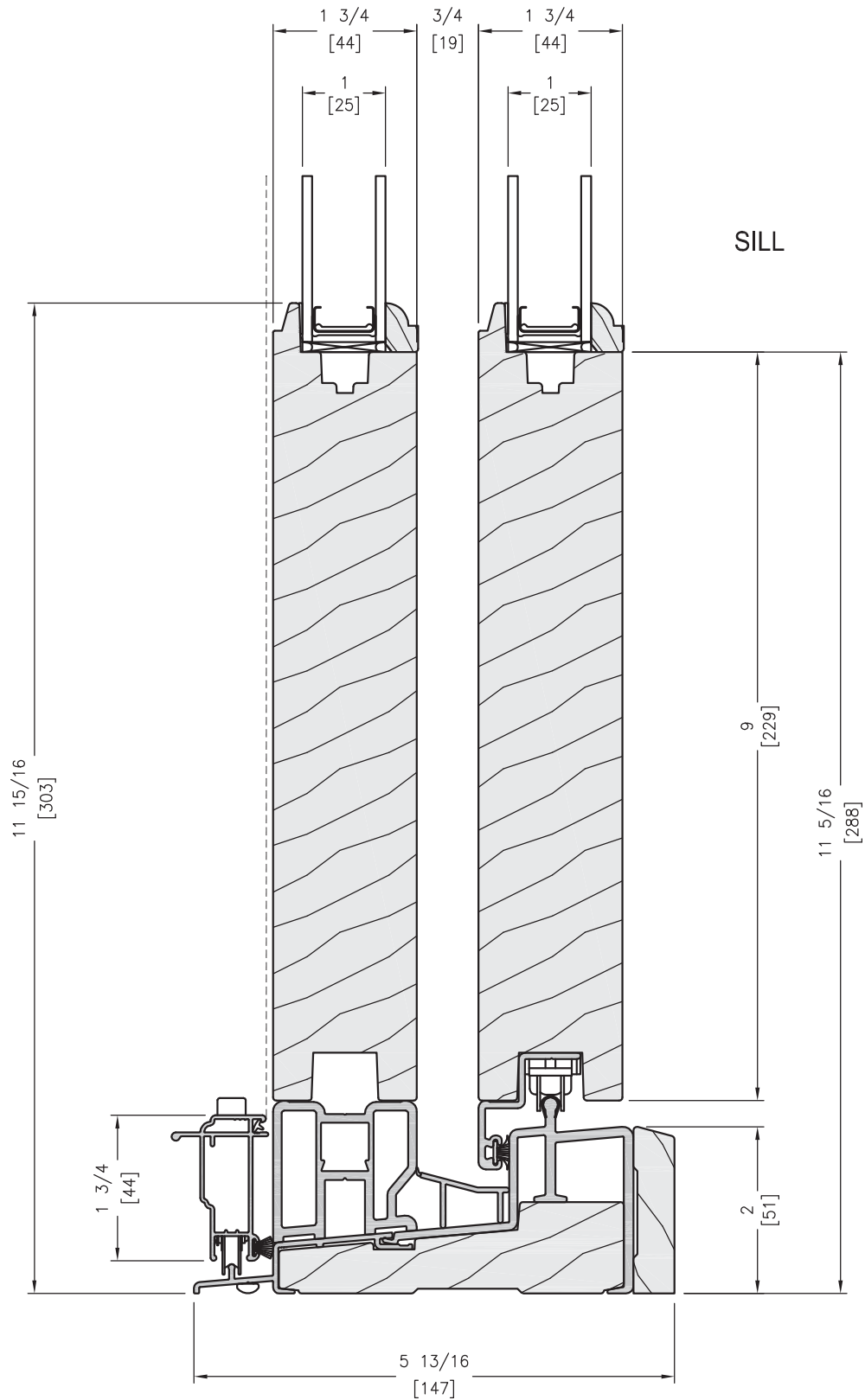

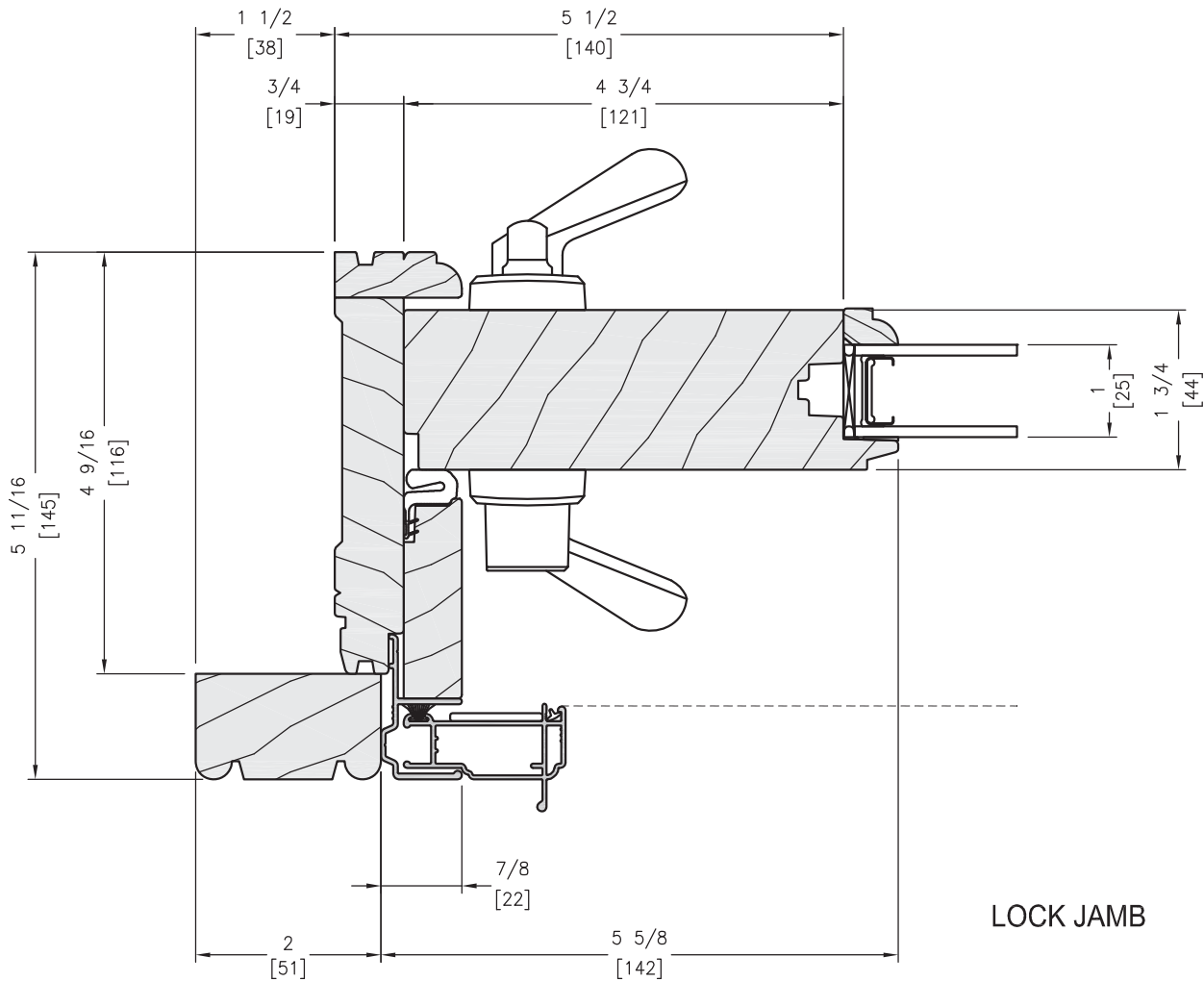
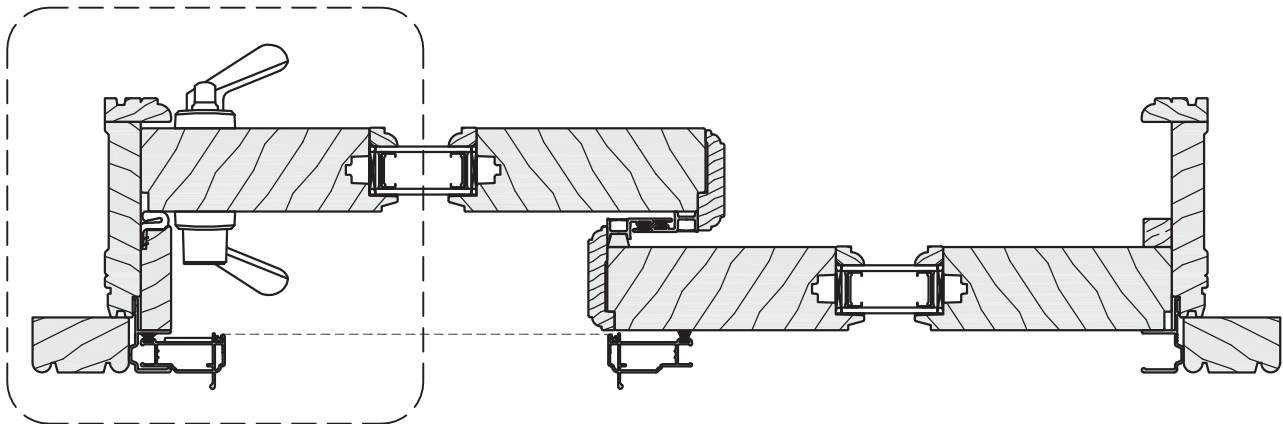
SCALE: 6" = 1'-0"
HORIZONTAL SECTION

LOCK JAMB

UNIT DRAWN WITH STANDARD BRICKMOULD

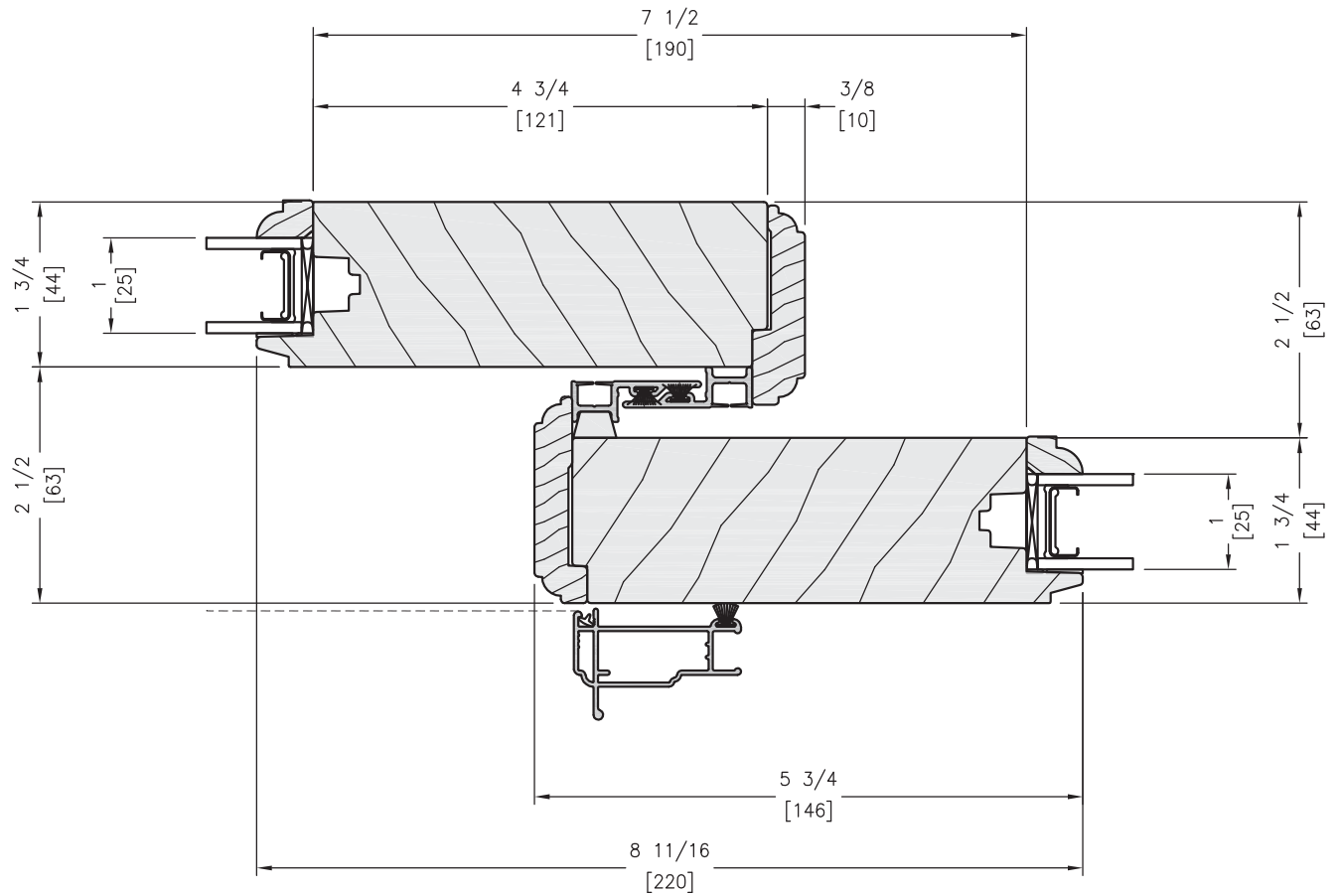
SCALE: 6" = 1'-0"

HORIZONTAL SECTION

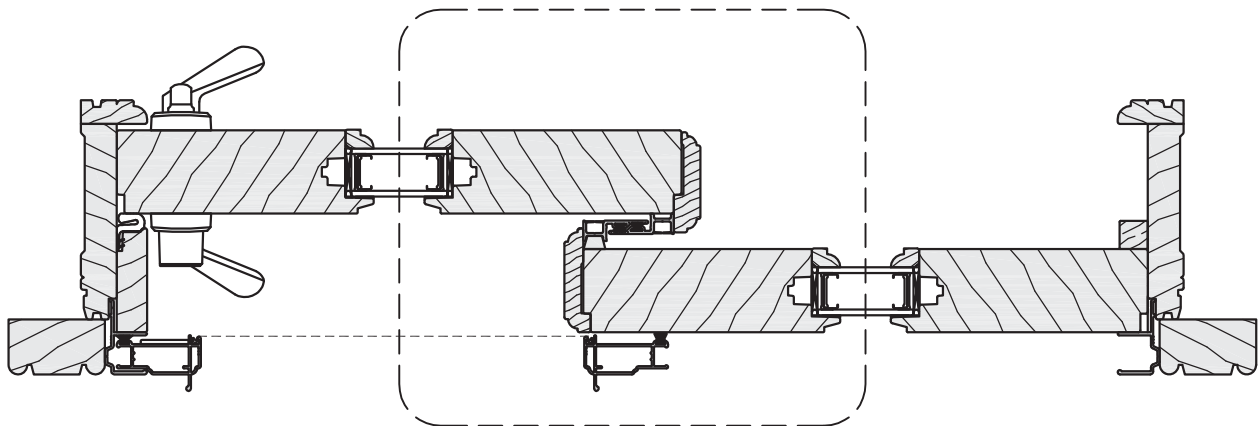

MEETING RAILS

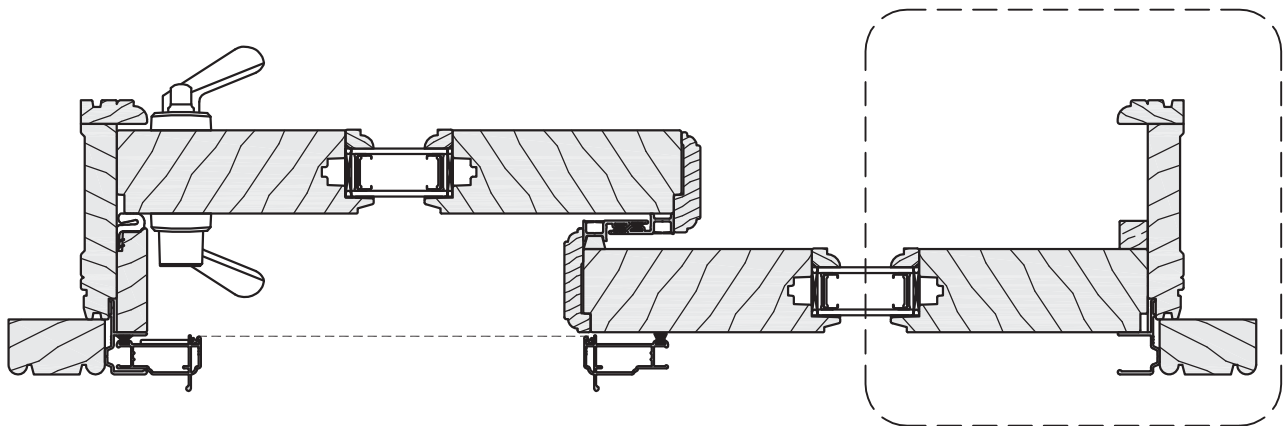
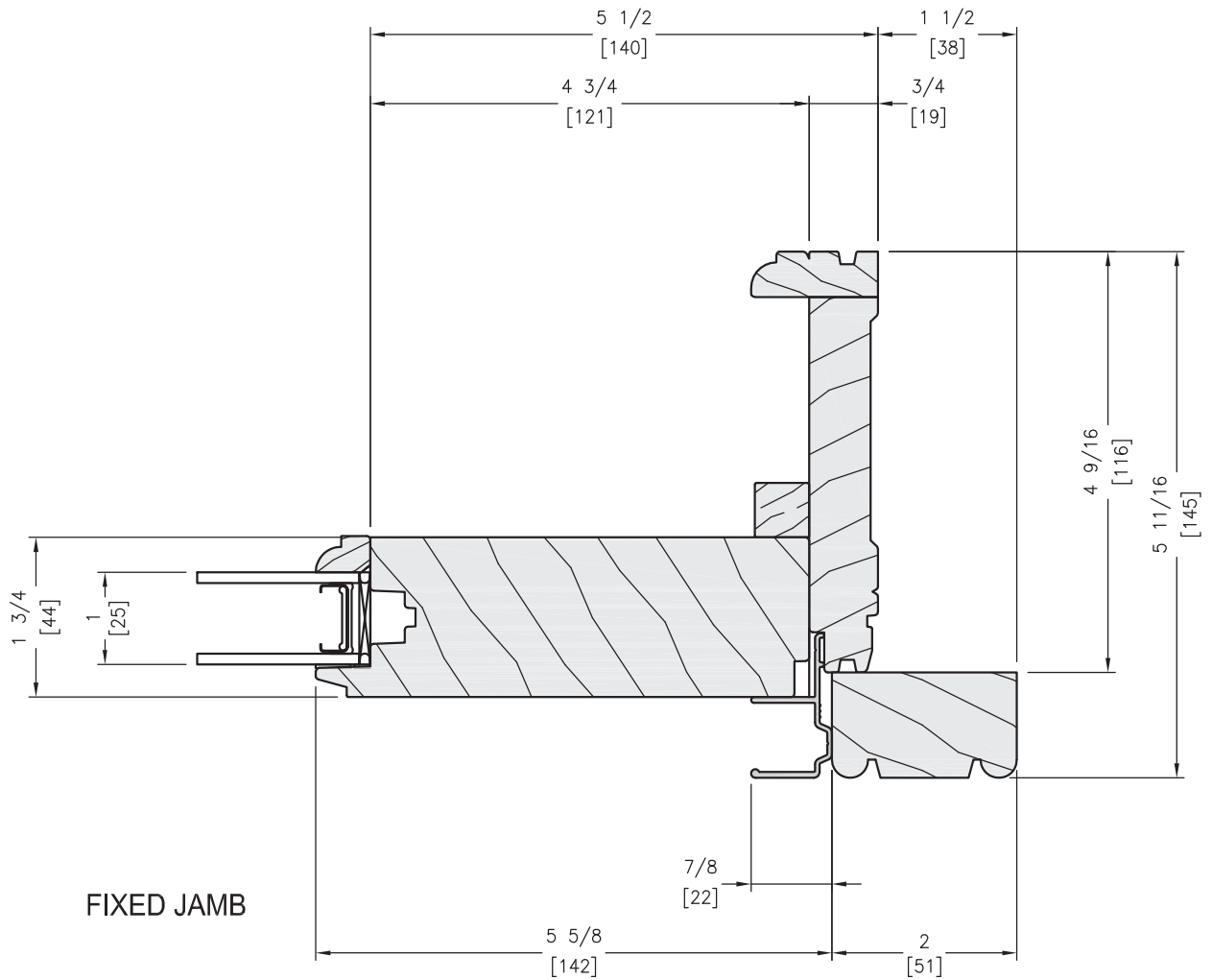

SCALE: 6" = 1'-0"
HORIZONTAL SECTION

UNIT DRAWN WITH STANDARD BRICKMOULD

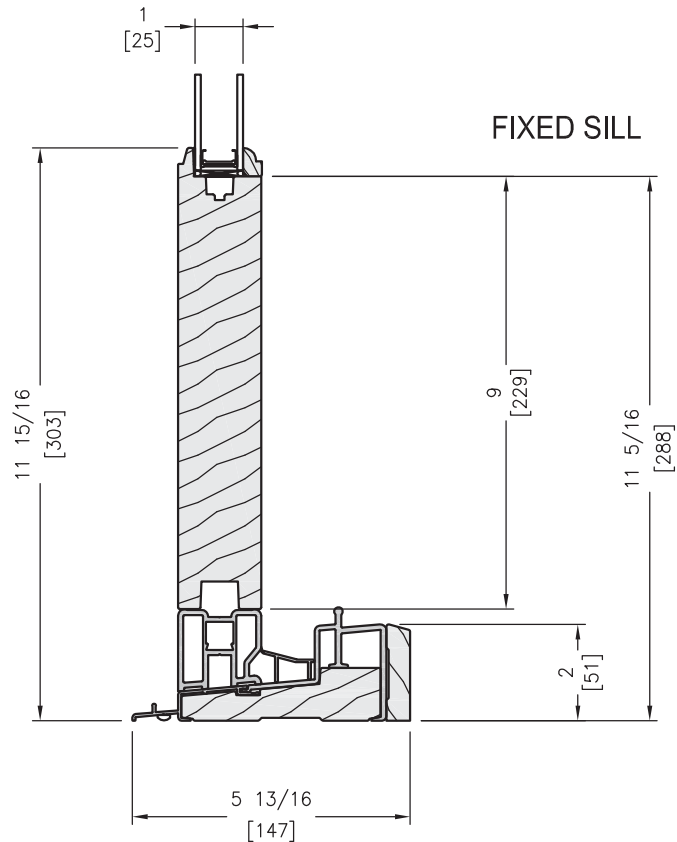
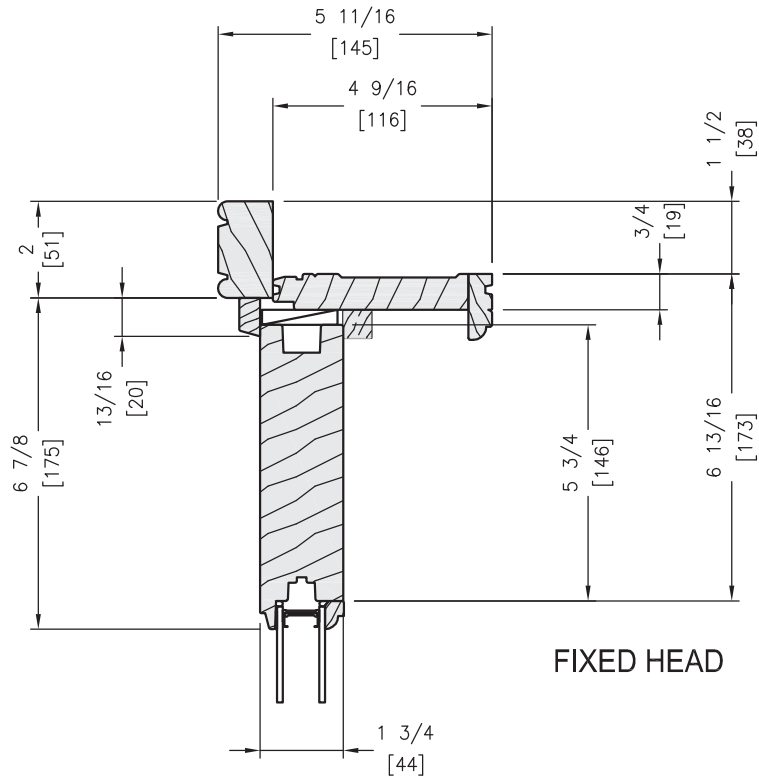
SCALE: 3" = 1'-0"
FIXED SIDELIGHT VERTICAL SECTION

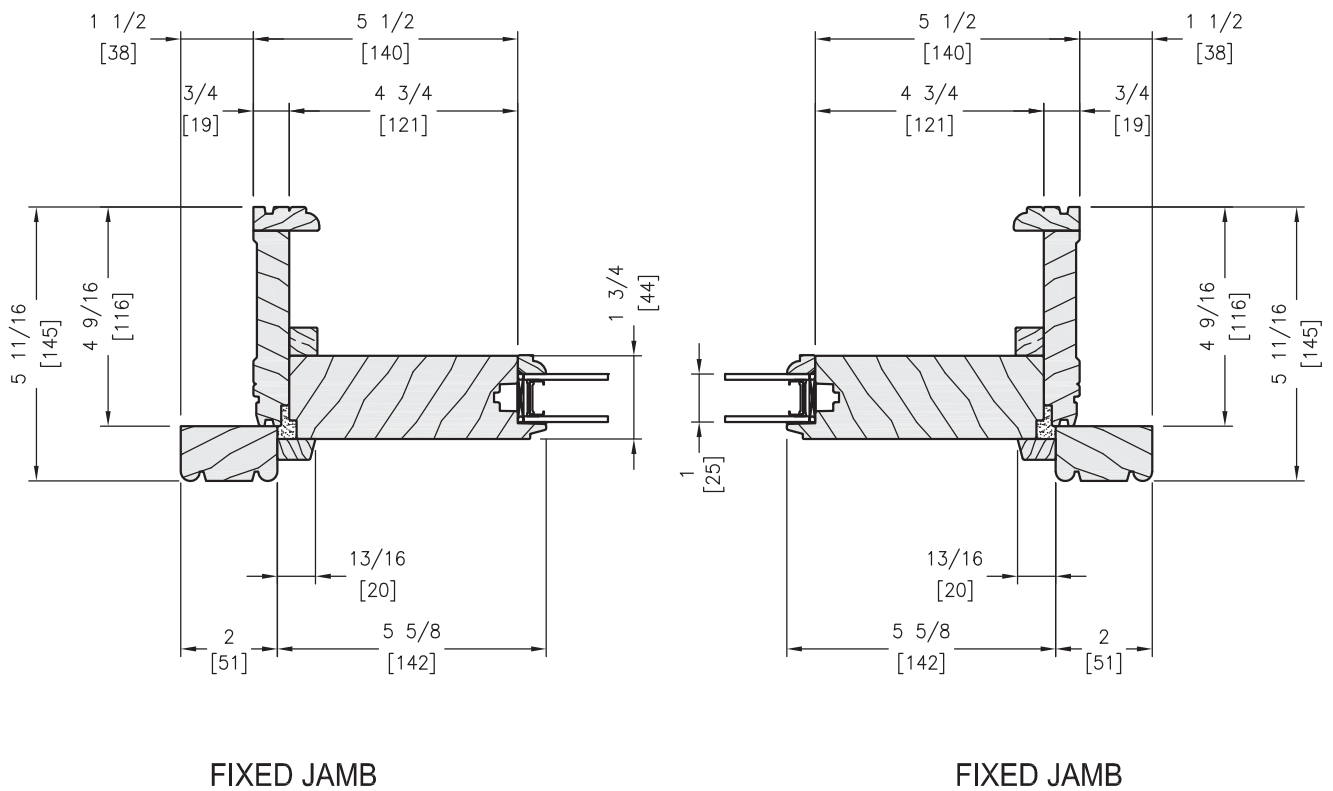
UNIT DRAWN WITH STANDARD BRICKMOULD

SCALE: 3" = 1'-0"
FIXED SIDELIGHT HORIZONTAL SECTION

UNIT DRAWN WITH STANDARD BRICKMOULD

SCALE: 3" = 1'-0"

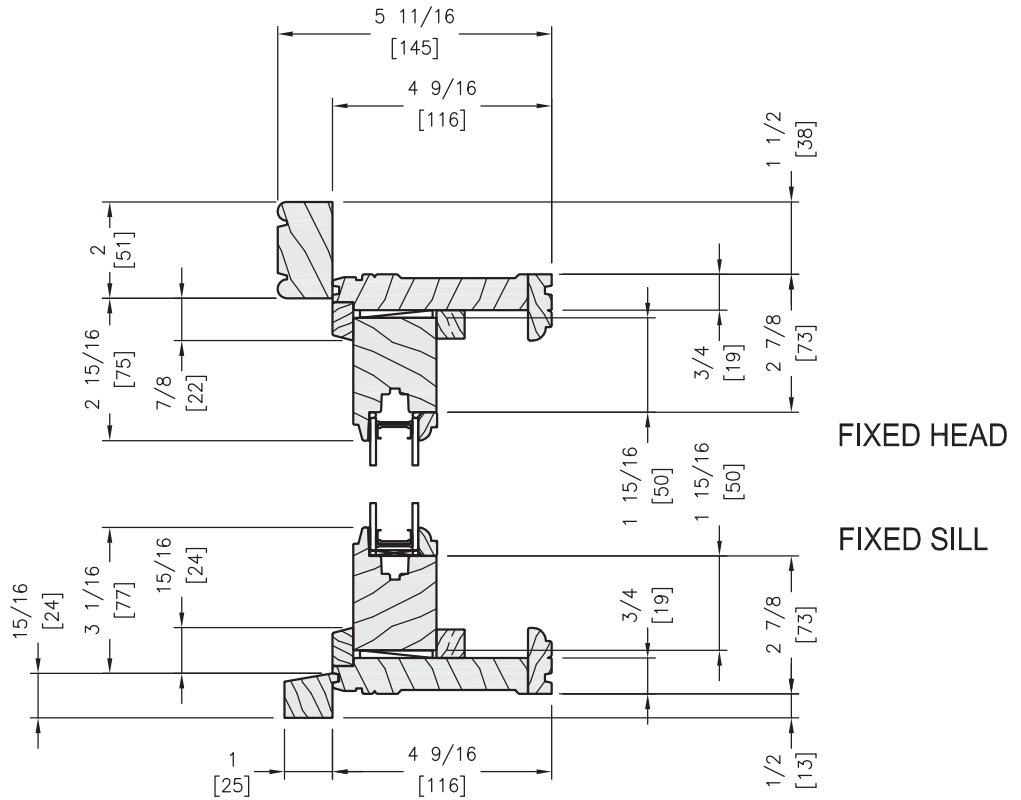
FIXED TRANSOM VERTICAL SECTION



SCALE: 3" = 1'-0"

FIXED TRANSOM HORIZONTAL SECTION

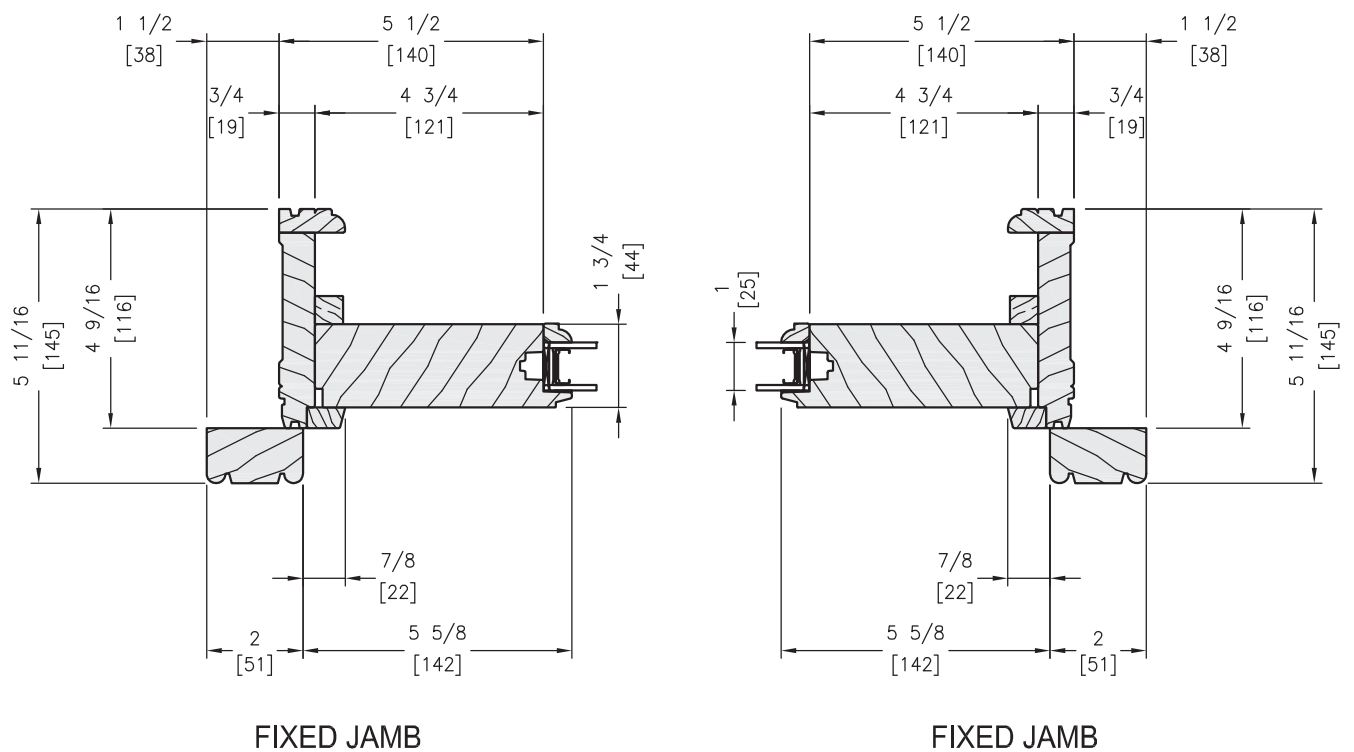

SCALE: 3" = 1'-0"

VERTICAL JOINING MULLIONS

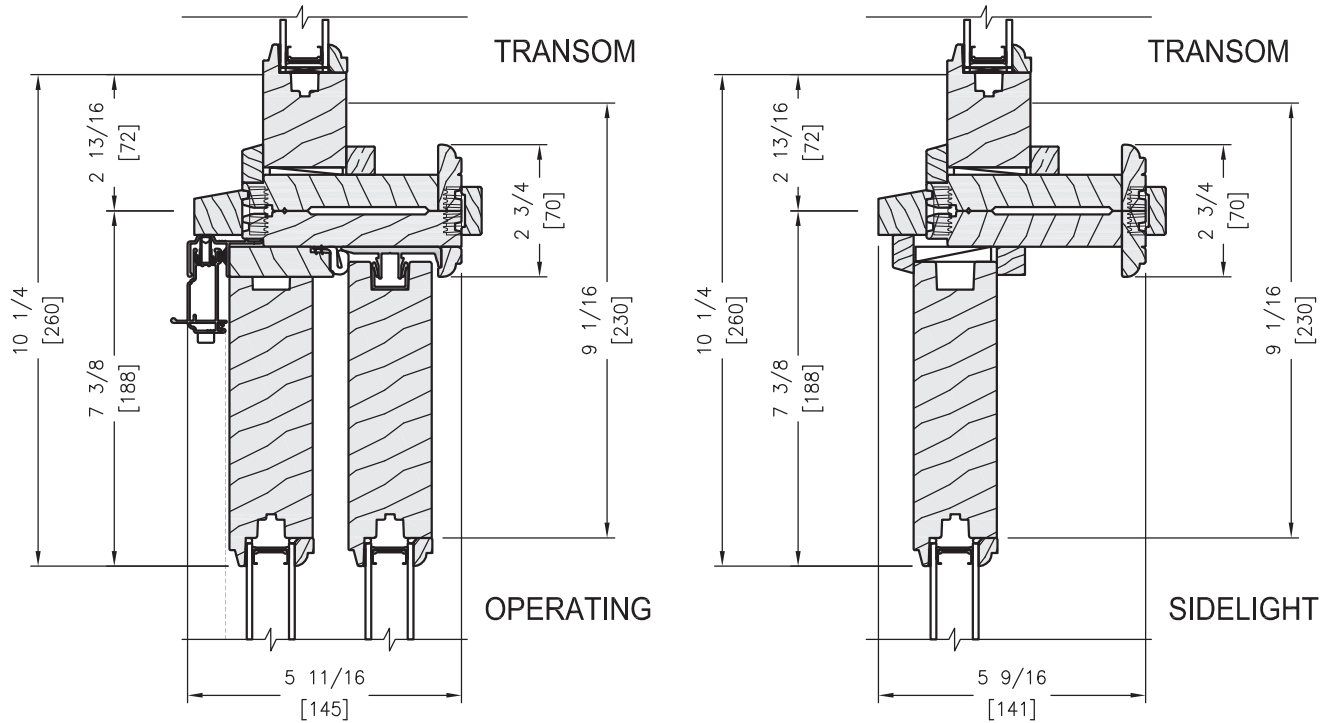

SCALE: 3" = 1'-0"

HORIZONTAL JOINING MULLIONS

