

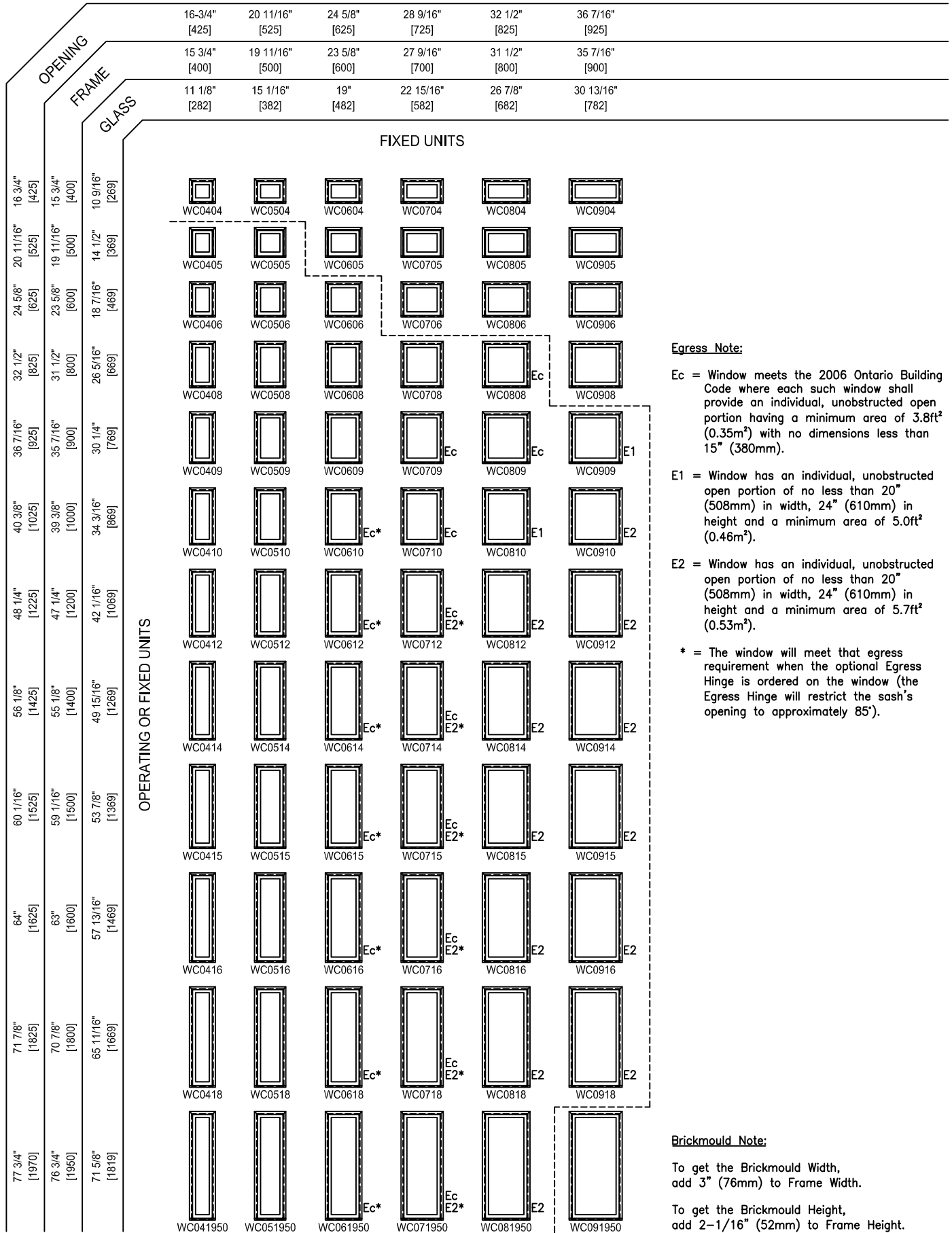













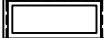
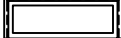
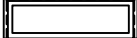
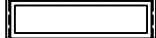



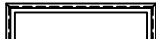

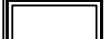
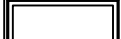
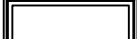
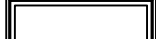

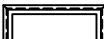
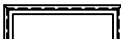
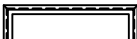
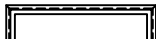

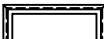
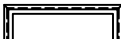
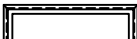
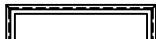





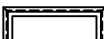
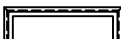
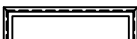
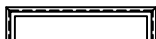

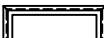
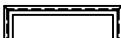
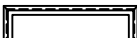
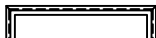
PRODUCT HIGHLIGHTS

GOLDENWOOD / GOLDENCLAD CASEMENT WINDOWS

- PRODUCT SIZE RANGE :**
- WIDTH 15 3/4" (400 mm) to 35 7/16" (900 mm) - PLUS MULLED UNITS -2, -3 OR -4
 - HEIGHT 23 5/8" (600 mm) to 76 3/4" (1950 mm)
 - STANDARD CATALOGUE and CUSTOM SIZES AVAILABLE
- PICTURE WINDOWS :**
- YES – STANDARD CATALOGUE and CUSTOM SIZES AVAILABLE
 - + COMBINE any OTHER SINGLE UNITS of SIMILAR HEIGHT to CREATE CASEMENT/PICTURE STYLE COMBINATIONS
- BAY / BOW WINDOWS :**
- YES – STANDARD CATALOGUE and CUSTOM SIZES AVAILABLE
 - + COMBINE any OTHER SINGLE UNITS of SIMILAR HEIGHT
 - 45 and 30 DEGREE ANGLE BAYS / 10 DEGREE ANGLE BOWS
 - + PINE HEAD and / or PINE SEAT BOARD OPTION
- GRILLE OPTIONS :**
- COLONIAL, VICTORIAN or MUSKOKA (SDL & GBG ONLY) PATTERNS in :
 - 1" REMOVABLE WOOD PROFILED BOTH SIDES with FULL SURROUND
 - 5/8" FLAT ALUMINUM BAR in WHITE, ALMOND, TAUPE, GREEN, SABLE and TAUPE/WHITE, SABLE/WHITE and 5/16" NARROW BRASS and PEWTER SEALED within INSUL GLASS (G.B.G.)
 - 3/4" PROFILED ALUMINUM GEORGIAN BAR in WHITE, ALMOND, TAUPE, GREEN, SABLE and TAUPE/WHITE, SABLE/WHITE within INSUL GLASS (G.B.G.)
 - 1" SIMULATED DIVIDED LITES (SDL) – ALUMINUM on all EXTERIORS –WOOD INTERIORS.
 - 2" SIMULATED HORIZONTAL MULLION GRILLE BAR (Alum. Ext./Wood Int.)
- GLAZING OPTIONS :**
- STANDARD INSUL UNIT CONSISTS of 2 pcs CLEAR 3mm GLASS with 1/2" WARM EDGE SPACER TECHNOLOGY (Choice of Standard "Intercept" or Upgrade to "SuperSpacer")
 - OR BRONZE or GREYLITE REPLACES OUTSIDE LITE of GLASS
 - OR GOLDENGLASS (highly recommended) with "LOW E" HARD COATING on INSIDE LITE of GLASS (#3 surface) + ARGON GAS ENHANCED AIR SPACE – Required for Energy Star rated windows or windows required to meet the new 2006 Ontario Building Code
 - TEMPERED and OBSCURE OPTIONS also AVAILABLE
- EXTERIOR FINISHES :**
- GOLDENWOOD – NATURAL PINE – FINGER JOINT EXTERIOR WOOD or
 - GOLDENCLAD – ALUMINUM CLAD EXTERIOR in 6 COLOURS :
- | | | |
|------------|-----------|---------------------------|
| A - ALMOND | S - SABLE | G - GREEN |
| T - TAUPE | W - WHITE | CR - CRANBERRY (OPTIONAL) |
- INTERIOR FINISHES :
And HARDWARE**
- ALL WOOD – CLEAR PINE FINISH
 - COPPERTONE or WHITE HARDWARE and SCREEN (SPECIFY COLOUR)
 - MULTIPOINT SINGLE LEVER LOCKING SYSTEM
 - TRUTH " MAXIM " ROTO OPERATOR on VENTING UNITS
 - OPTIONAL EGRESS HARDWARE or OPTIONAL LIMITING DEVICE
- JAMB EXTENSIONS :**
- GOLDENWOOD – STANDARD JAMB WIDTH 4 9/16"
 - GOLDENCLAD – OVERALL JAMB 5 11/16" (NAIL FIN OPTION)
 - YES – UP to 2" INSTALLED
 - CHOICE of CLEAR PINE (for STAIN) or FINGER JOINT (for PAINT)
- FEATURES & DETAILS :**
- REFER to LITERATURE / BROCHURES
- OPERATION :**
- SIDE HINGED SWINGING OUTWARD – HINGING ALWAYS as VIEWED FROM EXTERIOR – GENERALLY OUTSIDE LEFT SECTIONS are LEFT HINGED (L) and RIGHT PANELS RIGHT HINGED (R) – CENTRE AREA PANELS are CUSTOMER CHOICE
 - EXAMPLE : WC0616-4 with 2 VENTS (ie : WC0616-4 LFFR) LEFT HINGED (L), 2 FIXED CENTRE PANELS (FF), RIGHT HINGED (R)

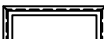
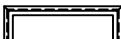
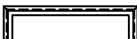

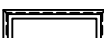
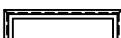
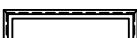
		40 3/8" [1025]	48 1/4" [1225]	56 1/8" [1425]	64" [1625]	71 7/8" [1825]
		39 3/8" [1000]	47 1/4" [1200]	55 1/8" [1400]	63" [1600]	70 7/8" [1800]
		34 3/4" [882]	42 5/8" [1082]	50 1/2" [1282]	58 3/8" [1482]	66 1/4" [1682]
		FIXED UNITS				
OPENING FRAME GLASS	16 3/4" [425]					
	20 11/16" [525]					
	24 5/8" [625]					
	32 1/2" [825]					
	36 7/16" [925]					
	40 3/8" [1025]					
	48 1/4" [1225]					
	56 1/8" [1425]					
	60 1/16" [1525]					
	64" [1625]					
	71 7/8" [1825]					
	77 3/4" [1970]					

Brickmould Note:

To get the Brickmould Width, add 3" (76mm) to Frame Width.

To get the Brickmould Height, add 2-1/16" (52mm) to Frame Height.

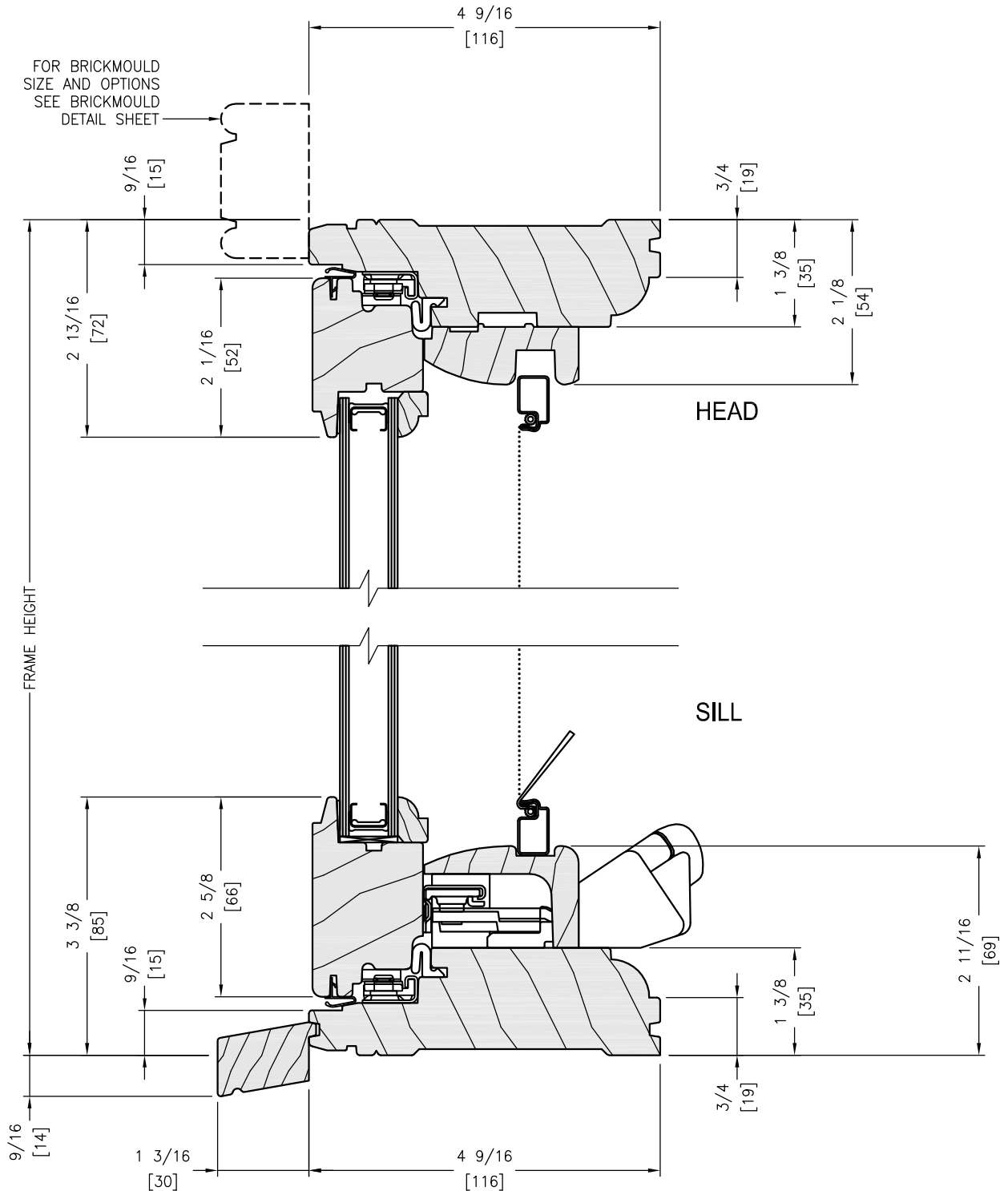
SCALE: 6" = 1'-0"
VERTICAL SECTION

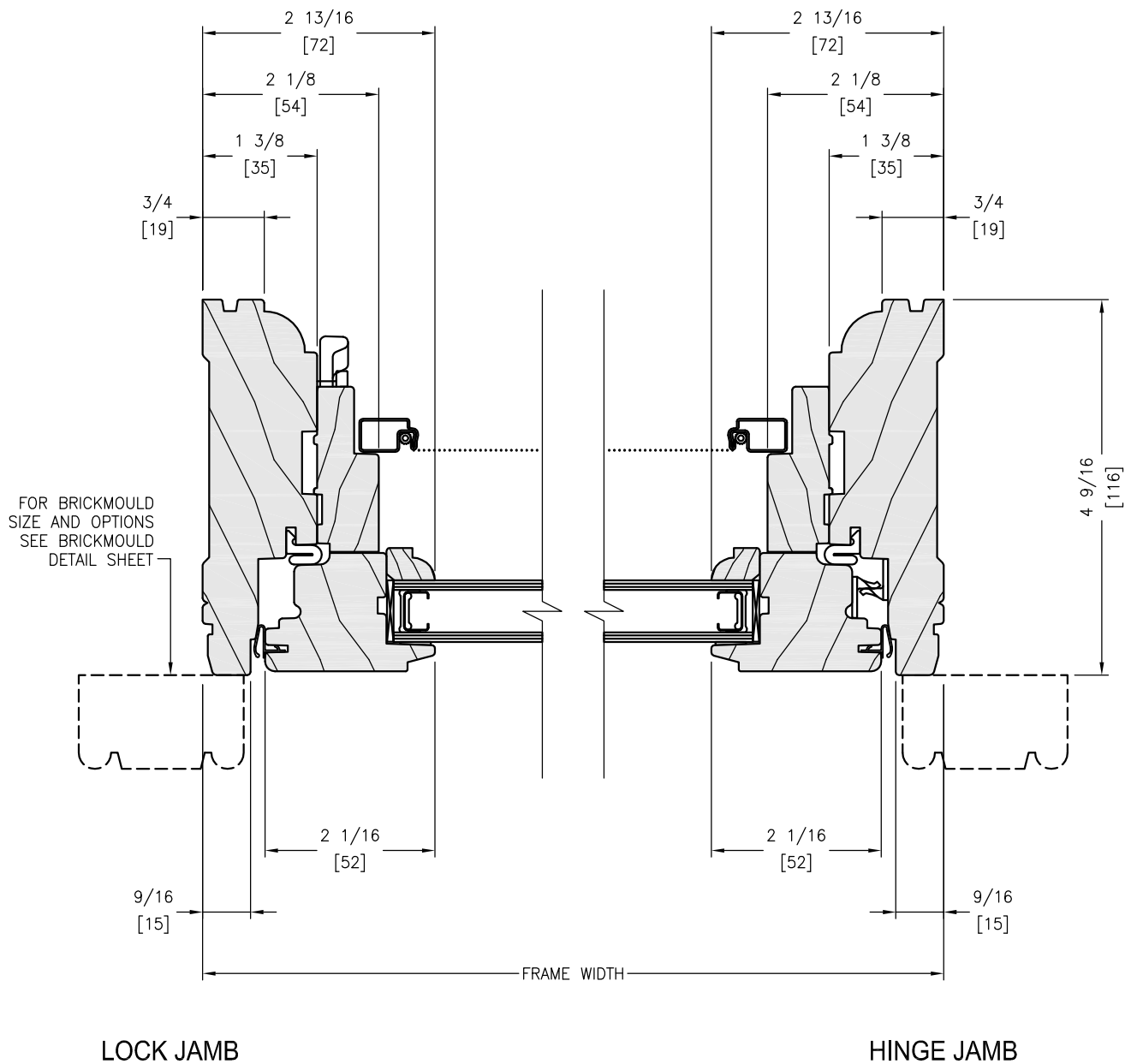
SCALE: 6" = 1'-0"
HORIZONTAL SECTION

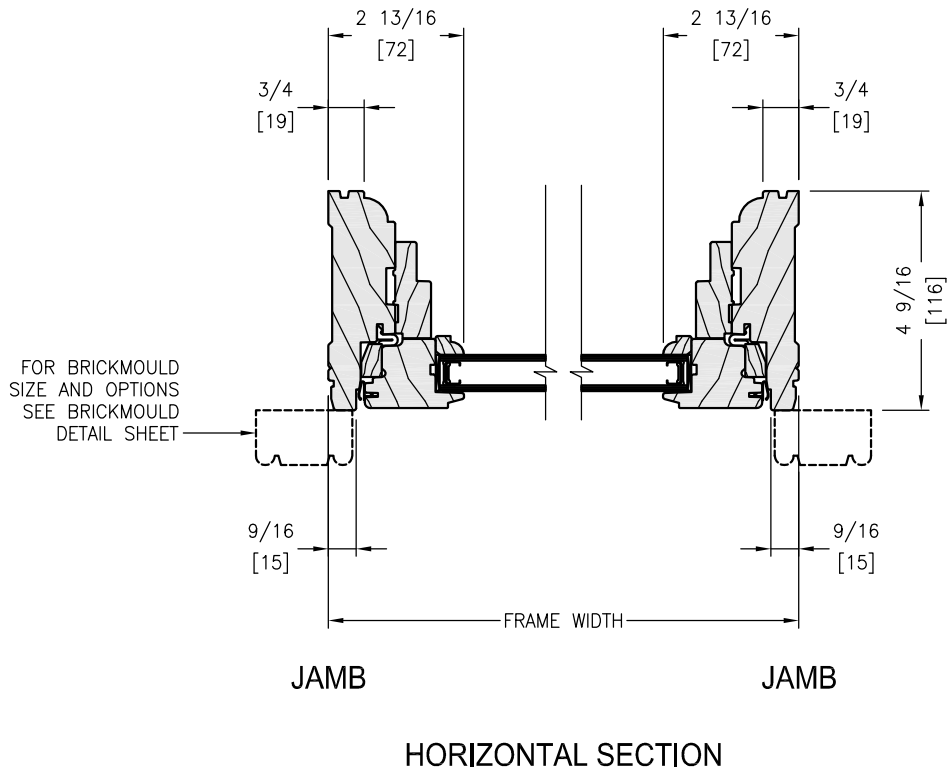
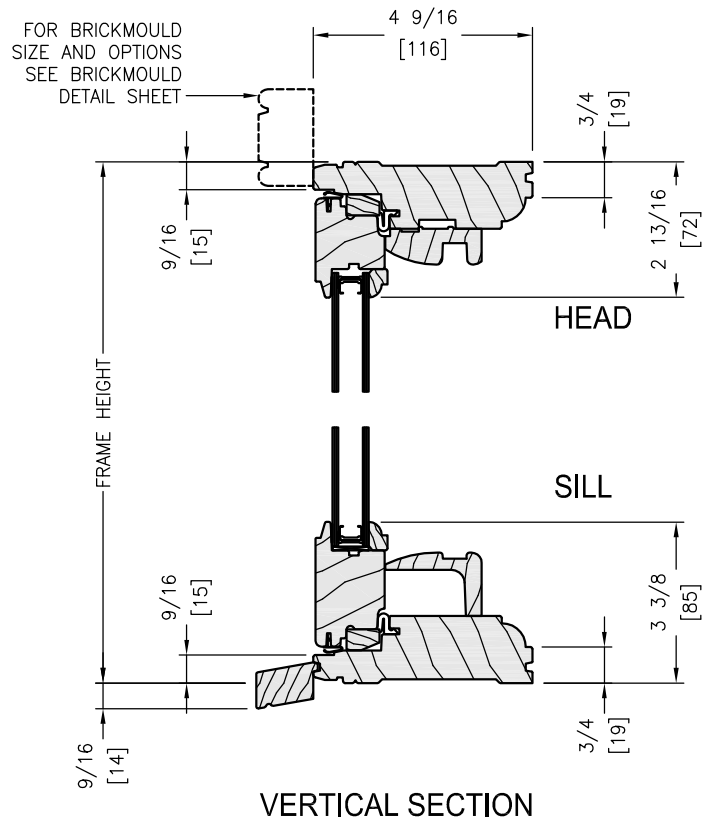
SCALE: 3" = 1'-0"
CASEMENT PICTURE / TRANSOM WINDOW

SCALE: 3" = 1'-0"

VERTICAL JOINING MULLIONS

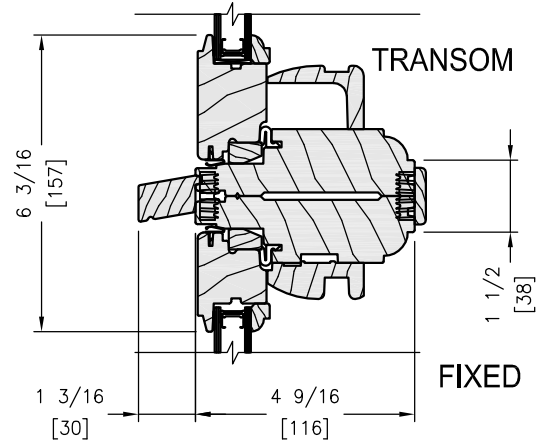
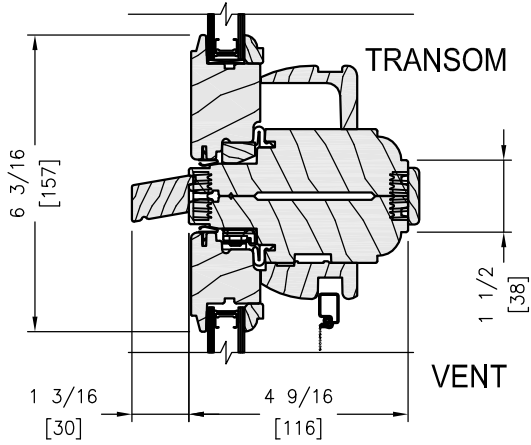

SCALE: 3" = 1'-0"

HORIZONTAL JOINING MULLIONS

